



懸掛照明系列

Suspension illumination series

30" ^{PC} _{PMMA} HIGH BAY FITTINGS

Hansin Lighting



HIGH BAY FITTINGS

PC30-05

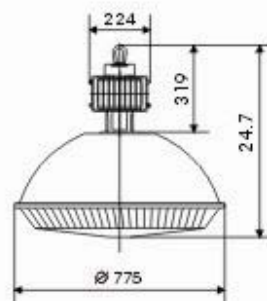

Operating Voltage: 220-240V/50Hz
Material: Die-Casting Gear Box with Aluminium Reflector And Pmma
Lamp: 400W-1000W
Packing: 10 pcs/ctn(80x80X35 cm) Diffuser 15/18kgs
6 pcs/ctn(78x78X20 cm) Gear Box 12.5/15kgs

22" ^{PC} _{PMMA} HIGH BAY FITTINGS

Hansin
Lighting

HIGH BAY FITTINGS



PC22-03



PC22-01



PC22-02



PC22-05

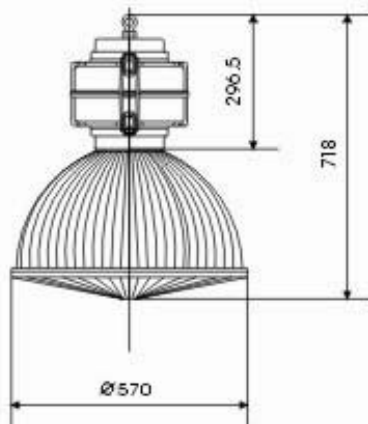

Operating voltage: 220-240 V/50HZ
 Material: Die Casting Aluminium(Gear Box)
 Polycarbonate+UV(Diffuser)
 Finishes: Black,White Silver(Gear Box)
 Packing: PC: 5 pcs/ctn(57.5x57.5x55 cm) Diffuser 12/14kgs
 Pmma: 5 pcs/ctn(57.5x57.5x58 cm) Diffuser 12/14kgs
 20 pcs/ctn(58x58x18 cm) cover 19/21kgs
 50 pcs/ctn(58x58x40 cm) stainless steel ring 11/12.5kgs
 100 pcs/ctn(86.5x36.5x48 cm) connector 16.5/18.5kgs

22" ^{PC} _{PMMA} HIGH BAY FITTINGS

Hansin
Lighting



PC22-08

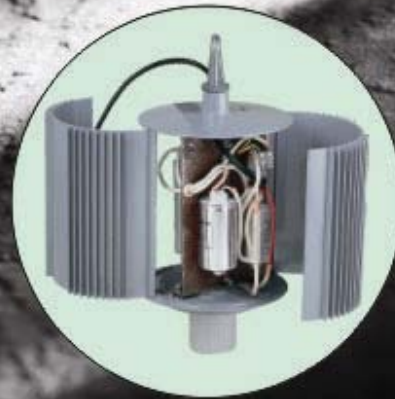

Operating voltage: 220-240V/50 Hz
 Material: Die Casting Aluminium (Gear Box)
 Polycarbonate+UV (Diffuser)
 Finishes: Black, White, Silver (Gear Box)
 Packing: PC: 5 pcs/ctn(57.5x57.5x55cm) Diffuser 12/14 kgs
 Pmma.5 pcs/ctn(57.5x57.5x58cm) Diffuser 12/14 kgs
 20pcs/ctn(58x58x18cm) cover 19/21 kgs
 50pcs/ctn(58x58x40cm) stainless steel ring 11/12.5 kgs
 100 pcs/ctn(86.5x36.5x48cm) connector 16.5/18.5 kgs

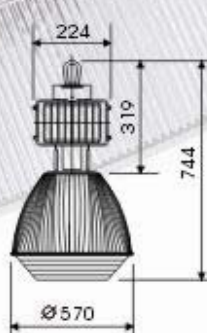
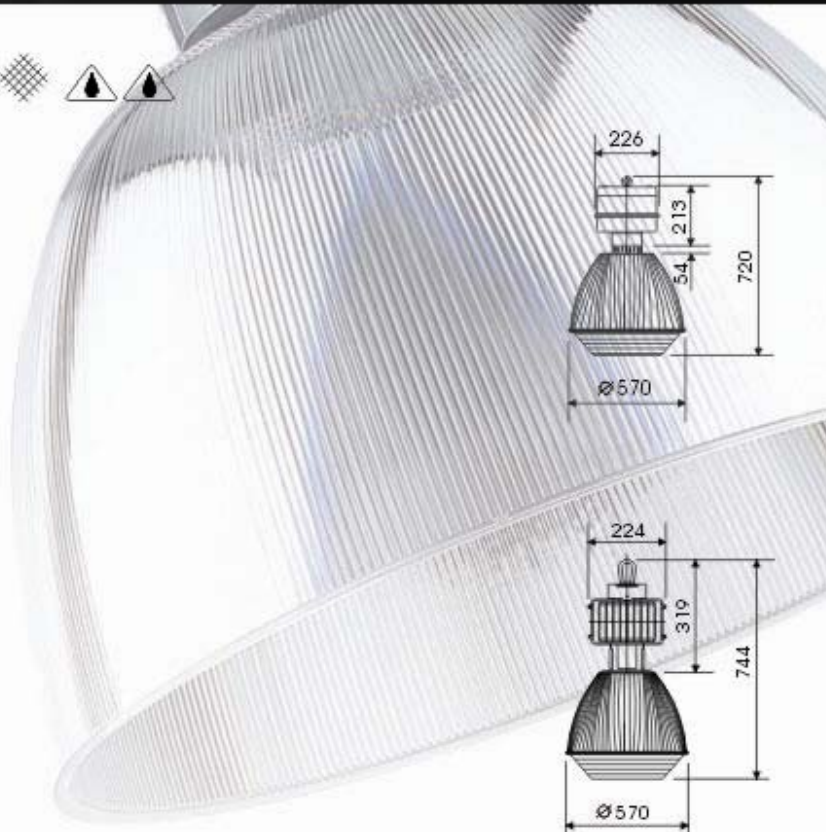

PC22A-01A



PC22A-05

HIGH BAY FITTINGS

16" ^{PC} _{PMMA} HIGH BAY FITTINGS

Hansin
Lighting



PC16A-01

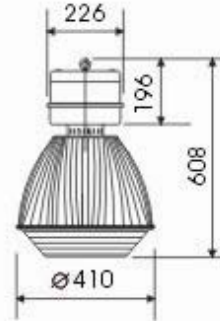

Operating voltage: 220-240V/50Hz
 Material: Die Casting Aluminium (Gear Box)
 Poly carbonate + UV (Diffuser)
 Finishes: Black/White/Silver (Gear Box)
 Packing: PC 10 pcs/ctn(42x42x69 cm) Diffuser 11/13 kgs
 Pmma. 10 pcs/ ctn(42x42x74 cm) Diffuser 11/13 kgs
 50 pcs/ ctn(42x42x30 cm) cover 21/22 kgs
 100 pcs/ ctn(43x43x45 cm) stainless steel ring 11.5/13.5 kgs
 100 pcs/ ctn(86.5x36.5x48 cm) connector 16.5/18.5 kgs

HIGH BAY FITTINGS

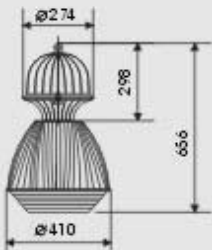

Operating voltage: 220-240V/50Hz
 Material: Die Casting Aluminium (Gear Box)
 Poly carbonate + UV (Diffuser)
 Finishes: Black/White/Silver (Gear Box)
 Packing: PC 10 pcs/ctn(42x42x69 cm) Diffuser 11/13 kgs
 Pmma. 10 pcs/ ctn(42x42x74 cm) Diffuser 11/13 kgs
 50 pcs/ ctn(42x42x30 cm) cover 21/22 kgs
 100 pcs/ ctn(43x43x45 cm) stainless steel ring 11.5/13.5 kgs
 100 pcs/ ctn(86.5x36.5x48 cm) connector 16.5/18.5 kgs



PC16A-02

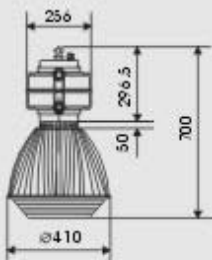

Operating voltage: 220-240V/50Hz
 Material: Die Casting Aluminium (Gear Box)
 Poly carbonate + UV (Diffuser)
 Finishes: Black/White/Silver (Gear Box)
 Packing: PC 10 pcs/ctn(42x42x69 cm) Diffuser 11/13 kgs
 Pmma. 10 pcs/ ctn(42x42x74 cm) Diffuser 11/13 kgs
 50 pcs/ ctn(42x42x30 cm) cover 21/22 kgs
 100 pcs/ ctn(43x43x45 cm) stainless steel ring 11.5/13.5 kgs
 100 pcs/ ctn(86.5x36.5x48 cm) connector 16.5/18.5 kgs



PC16A-03

16" PC DMMA HIGH BAY FITTINGS

Hansin
Lighting



PC16-01



PC16-01A



PC16-02



PC16-03



PC16-05

HIGH BAY FITTINGS

16" ^{PC} _{PMMA} HIGH BAY FITTINGS

Hansin
Lighting



PC16-06



PC16-06A



PC16-09



PC16-07

HIGH BAY FITTINGS

Operating voltage: 220-240V/50Hz
 Material: Die Casting Aluminium (Gear Box)
 Polycarbonate+UV (Diffuser)
 Finishes: Black, Silver (Gear Box)
 Packing: PC 10 pcs/ctn(33x33x34 cm) Diffuser 8.91kg
 PMMA 10 pcs/ctn(33x33x55 cm) Diffuser 8.91kg
 50 pcs/ctn(32.5x32.5x27 cm) cover 10.12.5kg
 50 pcs/ctn(32.5x32.5x39 cm) Y cover 10.12.5kg



12" P C HIGH BAY FITTINGS

Hansin
Lighting



PC12A

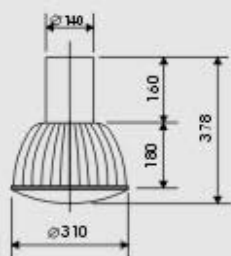

PC12E



Operating voltage: 220-240V/50 Hz
 Material: Die Casting Aluminium(Gear Box)
 Poly carbonate+UV Diffuser
 Finishes: Black, Silver(Gear Box)
 Packing: P C 10 pcs/ctn(33x33x54 cm)Diffuser 8.9 kgs
 P m a 10 pcs/ctn(33x33x55 cm) Diffuser 8.9 kgs
 50 pcs/ctn(32.5x32.5x27 cm)cover 10/12.5 kgs
 50 pcs/ctn(32.5x32.5x39 cm)Y cover 10/12.5 kgs



PC12B



PC12C



PC12D



HIGH BAY FITTINGS

HIGH BAY FITTINGS

Hansin
Lighting



PC Ø120



PC Ø160A



PC Ø160B



PC Ø160C



PC Ø160D



PC Ø160E



PC Ø160F



PC Ø160G



PC Ø160H



PC Ø258



30° CIRCLE



22° CIRCLE



16° CIRCLE

HIGH BAY FITTINGS

PC COVER

Hansin
Lighting



PC12" A



PC12" B



PC16" A



PC16" B



PC22" A



PC22" B



PC30"

PC REFLECTOR

PC
PMMA

REFLECTOR



PC16"



PC22" B



PC12"



PC22" A

HIGH BAY FITTINGS

GLASS HIGH BAY FITTINGS

Hansin
Lighting



G18-52A

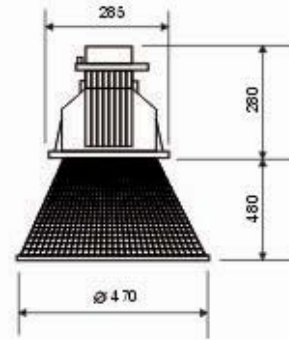

Operating Voltage: 220-240V/50Hz
Material: Die Casting Aluminium(Gear Box)
Glass+UV(Diffuser)
Finishes: Black,white Silver(Gear Box)

HIGH BAY FITTINGS

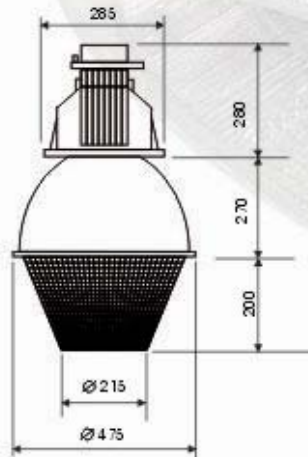

Operating Voltage: 220-240V/50Hz
Material: Die Casting Aluminium(Gear Box)
Glass+UV(Diffuser)
Finishes: Black,white Silver(Gear Box)



G18-52B



G16-52

HIGH BAY FITTINGS

Operating Voltage: 220-240V/50Hz
Material: Die Casting Aluminium(Gear Box)
Glass+UV(Diffuser)
Finishes: Black,white Silver(Gear Box)



16"GLASS HIGH BAY FITTINGS

G16-03

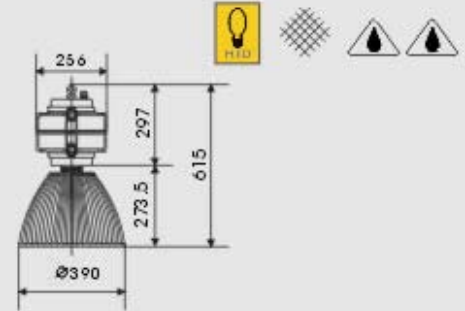

Operating Voltage: 220-240V/50 Hz
 Material: Die Casting Aluminium(Gear Box)
 Glass + UV(Diffuser)
 Finishes: Black,white Silver(Gear Box)
 Packing: 1 pcs/ctn.(40x40x29 cm)Diffuser 7/8 kgs
 6 pcs/ctn.(58.5x30x68 cm)Gear Box 22/24 kgs

G16-05

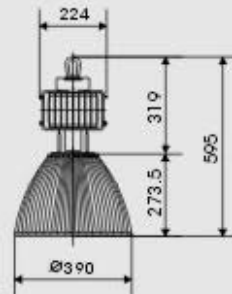

Operating Voltage: 220-240V/50 Hz
 Material: Die Casting Aluminium(Gear Box)
 Glass + UV(Diffuser)
 Finishes: Black,white Silver(Gear Box)
 Packing: 1 pcs/ctn.(40x40x29 cm)Diffuser 7/8 kgs
 6 pcs/ctn.(69x26.5x50 cm)Gear Box 16/18 kgs

G16-06

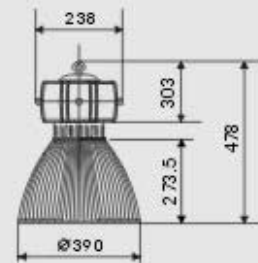

Operating Voltage: 220-240V/50 Hz
 Material: Die Casting Aluminium(Gear Box)
 Glass + UV(Diffuser)
 Finishes: Black,white Silver(Gear Box)
 Packing: 1 pcs/ctn.(40x40x29 cm)Diffuser 7/8 kgs
 6 pcs/ctn.(65x22.5x45 cm)Gear Box 9/11 kgs

HIGH BAY FITTINGS



GLASS HIGH BAY FITTINGS

Hansin
Lighting



G12A-A



G12A-B



G12A-C



G12A-D

Operating voltage: 220-240V/50HZ
Material: Aluminium Reflector And Glass

HIGH BAY FITTINGS

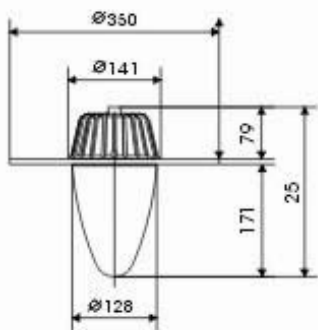

Operating voltage: 220-240V/50HZ
Material: Glass

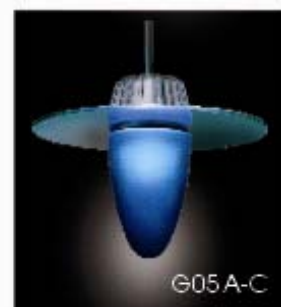

GLASS HIGH BAY FITTINGS

Hansin
Lighting

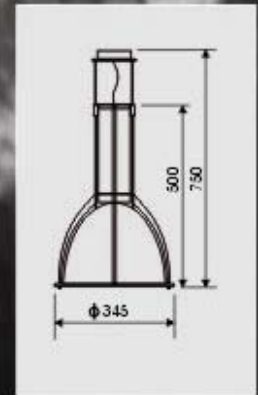

HIGH BAY FITTINGS



G12B

Operating voltage: 220-240V/50HZ

Material: Aluminium Reflector And Glass

ALUMINIUM REFLECTOR HIGH BAY FITTINGS

Hansin
Lighting



AL20-01



AL20-02



AL20-07

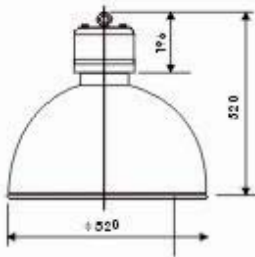

Material: Aluminium Reflector
Die-casting Aluminium Gear Box
Finishes: Black, Silver(Gear Box)
Packing: 10 pcs/ctn(55 x 55 x 58 cm)(Diffuser) 10.5 / 13.5 kgs
6 pcs/ctn(70 x 24 x 48 cm)(Gear Box) 10 / 12 kgs
5 pcs/ctn(3.5 x 3.5 x 8.5 cm)(Cover) 13.5 x 14.5 kgs

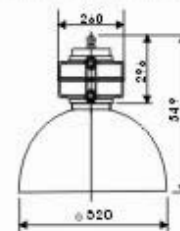

Material: Aluminium Reflector
Die-casting Aluminium Gear Box
Finishes: Black, Silver(Gear Box)
Packing: 10 pcs/ctn(54 x 54 x 57 cm)(Diffuser) 10 / 13 kgs
6 pcs/ctn(58.5 x 30 x 8 cm)(Gear Box) 22 / 24 kgs



AL20-03



AL20-05



ALUMINIUM REFLECTOR HIGH BAY FITTINGS

Hansin
Lighting

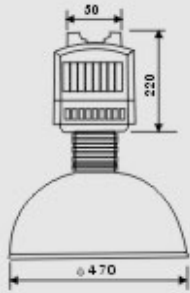

AL18A

Material: Aluminium Reflector
Die-casting Aluminium Gear Box
Finishes: Black, Silver (Gear Box)
Packing: 10 pcs/ ctn (50x50x36cm) (Diffuser)
4 pcs/ ctn (37x35x36cm) (Gear Box)

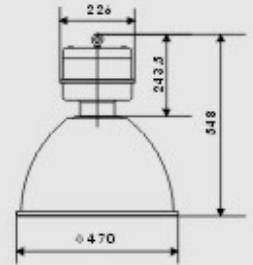

AL18C-01A

Material: Aluminium Reflector
Die-casting Aluminium Gear Box
Finishes: Black, Silver (Gear Box)
Packing: 10 pcs/ ctn (50x50x48.5cm) (Diffuser)
6 pcs/ ctn (70x24x36cm) (Gear Box)
5 pcs/ ctn (48.5x48.5x9cm) (Cover)

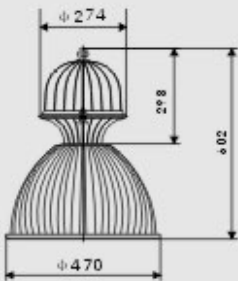

AL18B-02

Material: Aluminium Reflector
Die-casting Aluminium Gear Box
Finishes: Black, Silver (Gear Box)
Packing: 10 pcs/ ctn (50x50x58cm) (Diffuser)
2 pcs/ ctn (58x30x28.5cm) (Gear Box)
5 pcs/ ctn (48.5x48.5x9cm) (Cover)

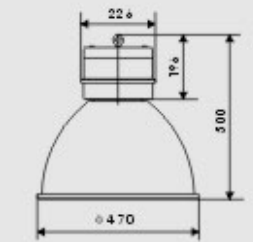

AL18D-01

Material: Aluminium Reflector
Die-casting Aluminium Gear Box
Finishes: Black, Silver (Gear Box)
Packing: 10 pcs/ ctn (50x50x48.5cm) (Diffuser)
10 pcs/ ctn (50x50x58cm) (Diffuser)
6 pcs/ ctn (70x24x46cm) (Gear Box)

HIGH BAY FITTINGS

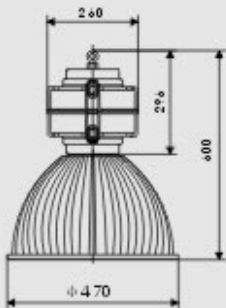

AL18B-03

Material: Aluminium Reflector
Die-casting Aluminium Gear Box
Finishes: Black, Silver (Gear Box)
Packing: 10 pcs/ ctn (50x50x58cm) (Diffuser)
6 pcs/ ctn (58.5x30x68cm) (Gear Box)
5 pcs/ ctn (48.5x48.5x9cm) (Cover)

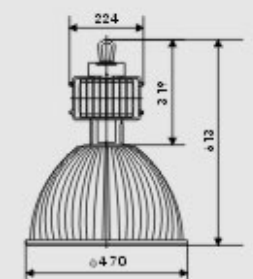

AL18E-05

Material: Aluminium Reflector
Die-casting Aluminium Gear Box
Finishes: Black, Silver (Gear Box)
Packing: 10 pcs/ ctn (50x50x58cm) (Diffuser)
10 pcs/ ctn (50x50x58cm) (Diffuser)
6 pcs/ ctn (69x26.5x50cm) (Gear Box)

ALUMINIUM REFLECTOR HIGH BAY FITTINGS

Hansin
Lighting



AL16

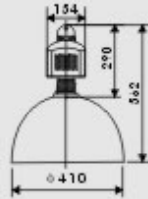

Material: Aluminium Reflector
Tempered Glass Cover
Die Casting Aluminium (Gear Box)
Finishes: Black, Silver (Gear Box)
Packing: 20 pcs/ctn (43x43x56cm) (Diffuse)
23 pcs/ctn (43x43x46cm) (Cover)
4 pcs/ctn (37x35x25 cm) (Gear Box)

AL16D



HIGH BAY FITTINGS



AL16B

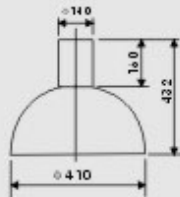

Material: Aluminium Reflector
Tempered Glass Cover
Die Casting Aluminium (Gear Box)
Finishes: Black, Silver (Gear Box)
Packing: 20 pcs/ctn (43x43x56cm) (Diffuse)
12 pcs/ctn (43x29x34 cm) (Gear Box)

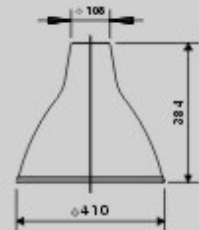

Material: Aluminium Reflector
Die Casting Aluminium (Gear Box)
Finishes: Black, Silver (Gear Box)
Packing: 5 pcs/ctn (42x42x60cm) (Diffuse)



AL16-06

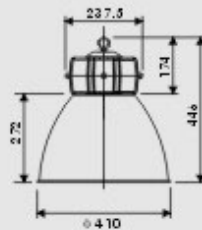

Material: Aluminium Reflector
Die Casting Aluminium (Gear Box)
Finishes: Black, Silver (Gear Box)
Packing: 20 pcs/ctn (43x43x56 cm) (Diffuse)
6 pcs/ctn (65x22.5x45 cm) (Gear Box)



ALUMINIUM REFLECTOR HIGH BAY FITTINGS

Hansin
Lighting



HIGH BAY FITTINGS

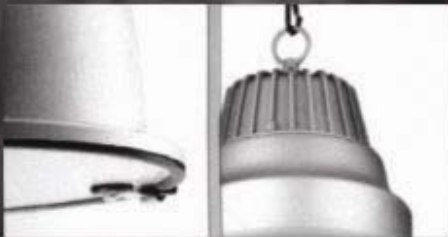

AL16A



Operating voltage: 220-240V 50 Hz
Material: steel with Aluminium Reflector
Glass + W(Diffuser)
Lamp: 150W Max
Material: Steel with Aluminium Reflector
and Die-Casting holder



ALUMINIUM REFLECTOR HIGH BAY FITTINGS

Hansin
Lighting

HIGH BAY FITTINGS

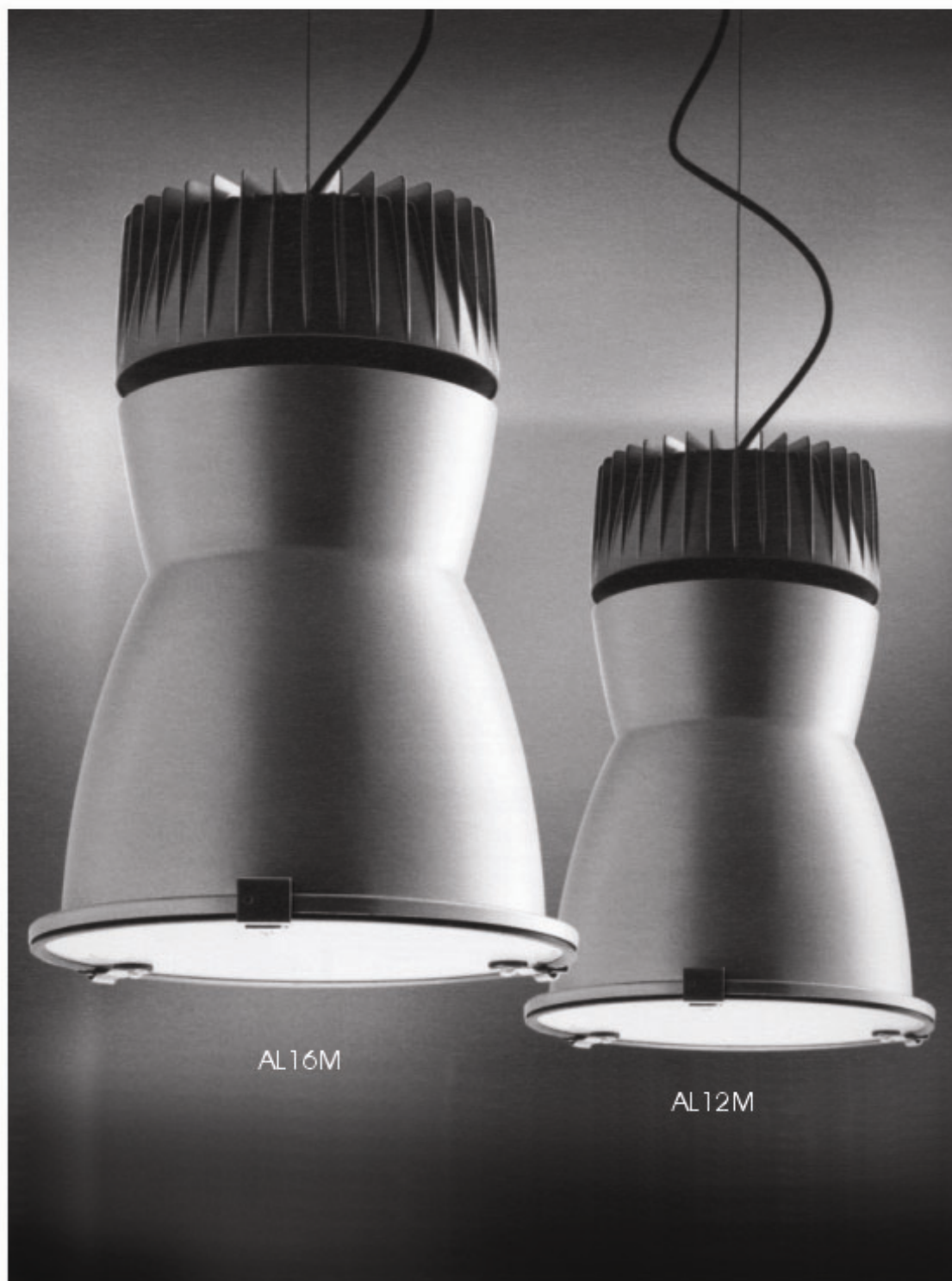

AL16M

AL12M

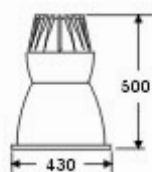
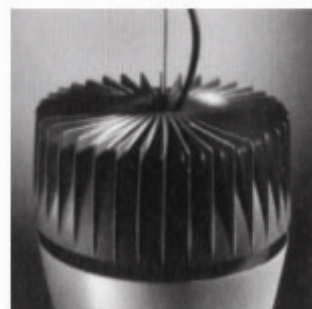

AL16M

Operating voltage: 220-240V/50Hz
Material: steel with Aluminium Reflector
Glass+Uv(Diffuser)
Lamp 250W Max
Material: Steel with Aluminum Reflector
and Die-Casting holder

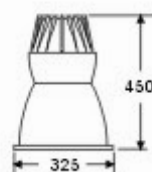

AL12M

Operating voltage: 220-240V/50Hz
Material: steel with Aluminium Reflector
Glass+Uv(Diffuser)
Lamp 140W/150W Max
Material: Steel with Aluminum Reflector
and Die-Casting holder

ALUMINIUM REFLECTOR HIGH BAY FITTINGS

Hansin
Lighting



AL16N



AL12N

HIGH BAY FITTINGS

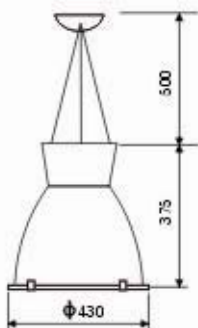

AL16N

Operating voltage: 220-240V/50 Hz
Material: steel with Aluminium Reflector
Glass+UV(Diffuser)
Packing: 1 PC / ctn(44x44x47 cm)

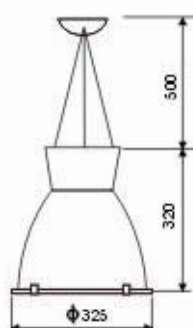

AL12N

Operating voltage: 220-240V/50 Hz
Material: steel with Aluminium Reflector
Glass+UV(Diffuser)
Packing: 1 PC / ctn(34x34x35 cm)



ALUMINIUM REFLECTOR HIGH BAY FITTINGS

Hansin
Lighting

HIGH BAY FITTINGS



AL12F

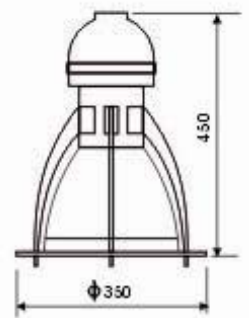
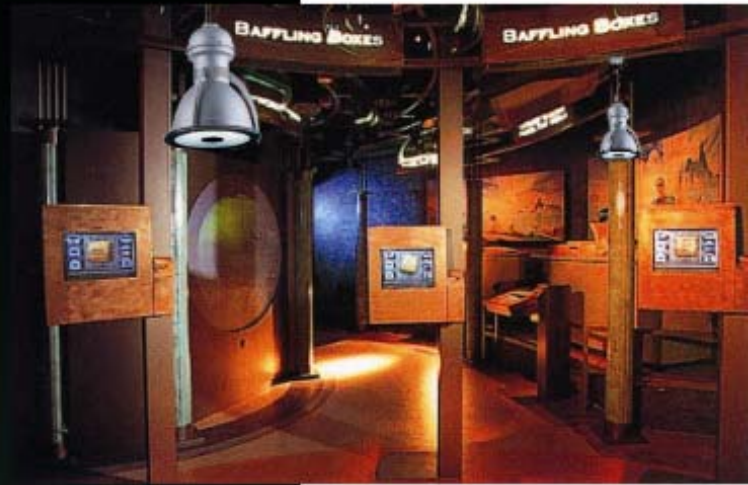

Operating voltage: 220-240 V/50HZ
Material: steel with Aluminium Reflector
Glass + UV (Diffuser)



ALUMINIUM REFLECTOR HIGH BAY FITTINGS

Hansin
Lighting



AL12A

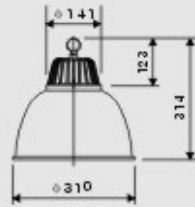

Operating Voltage: 220-240V/50Hz
Material: Aluminium Reflector
Die Casting Aluminium
Finishes: Black, Silver (Gear Box)
Packing: 10 pcs/ctn (32x32x61 cm) (Diffuser)
20 pcs/ctn (31x31x47 cm) (Gear Box)

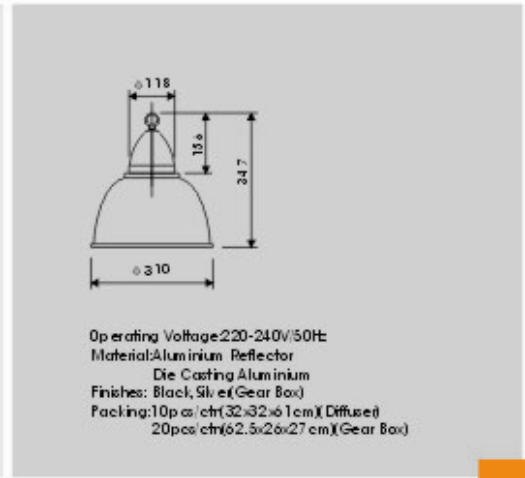

AL12D

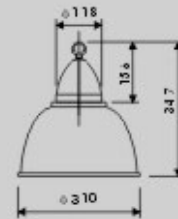

Operating Voltage: 220-240V/50Hz
Material: Aluminium Reflector
Die Casting Aluminium
Finishes: Black, Silver (Gear Box)
Packing: 10 pcs/ctn (32x32x61 cm) (Diffuser)
20 pcs/ctn (32.5x26x27 cm) (Gear Box)



AL12B

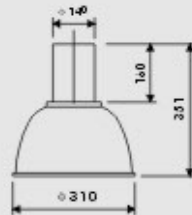

Material: Aluminium Reflector
Die Casting Aluminium
Finishes: Black, Silver (Gear Box)
Packing: 25 pcs/ctn (32x32x61 cm) (Diffuser)
12 pcs/ctn (43x29x34 cm) (Gear Box)



AL12C

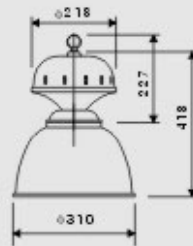

Operating Voltage: 220-240V/50Hz
Material: Aluminium Reflector
Die Casting Aluminium
Finishes: Black, Silver (Gear Box)
Packing: 10 pcs/ctn (32x32x61 cm) (Diffuser)
24 pcs/ctn (58x58x54 cm) (Gear Box)



HIGH BAY FITTINGS



CONTROL GEAR BOX



XT01

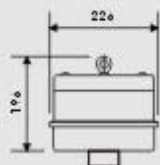

Material: Die Casting Aluminium
Lamp holder: E40
Max. MH 400W/ HPS 400W
Protection standard: IP 44
Colour: black, silver, grey
Packing: 6 pcs/ ctn (70x24x46cm)
G.W: 12 KGS



XT01A

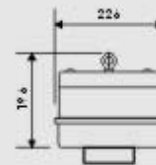

Material: Die Casting Aluminium
Lamp holder: E40
Max. MH 400W/ HPS 400W
Protection standard: IP 44
Colour: black, silver, grey
Packing: 6 pcs/ ctn (70x24x46cm)
G.W: 12 KGS



XT02



Material: Die Casting Aluminium
Lamp holder: E40
Max. MH 400W/ HPS 400W
Protection standard: IP 44
Colour: black, silver, grey
Packing: 2 pcs/ ctn (58x30x28.5 cm)
G.W: 7 KGS



XT03

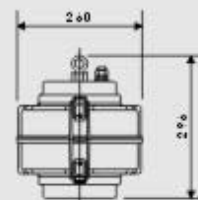

Material: Die Casting Aluminium
Lamp holder: E40
Max. MH 400W/ HPS 400W
Protection standard: IP 44
Colour: black, silver, grey
Packing: 6 pcs/ ctn (58.5x30x68 cm)
G.W: 24 KGS



XT05A 400W

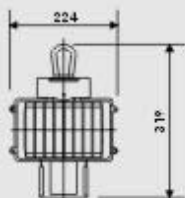

Material: Die Casting Aluminium
Lamp holder: E40
Max. MH 400W/ HPS 400W
Protection standard: IP 44
Colour: black, silver, grey
Packing: 6 pcs/ ctn (69x26.5x30 cm)
G.W: 18 KGS



XT05B 1000W

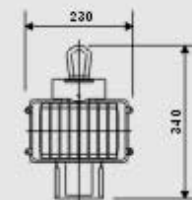

Material: Die Casting Aluminium
Lamp holder: E40
Max. MH 400W/ HPS 400W
Protection standard: IP 44
Colour: black, silver, grey
Packing: 6 pcs/ ctn (63x22.5x45 cm)
G.W: 11 KGS



XT06

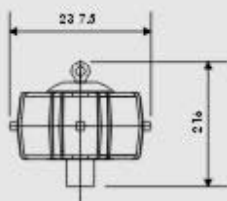

Material: Die Casting Aluminium
Lamp holder: E40
Max. MH 400W/HPS 400W
Protection standard: IP 44
Colour: black, silver, grey
Packing: 6 pcs/ctn (65x22.5x45 cm)
G.W: 11 KGS



XT07

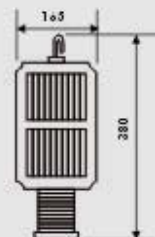

Material: Die Casting Aluminium
Lamp holder: E40
Max. MH 400W/HPS 400W
Protection standard: IP 44
Colour: black, silver, grey
Packing: 6 pcs/ctn (70x24x46 cm)
G.W: 12 KGS



XT08

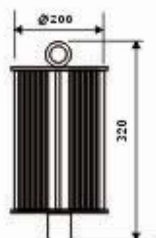

Material: Die Casting Aluminium
Lamp holder: E40
Max. MH 400W/HPS 400W
Protection standard: IP 44
Colour: black, silver, grey
Packing: 2 pcs/ctn (58x30x28.5 cm)
G.W: 7 KGS



XT09

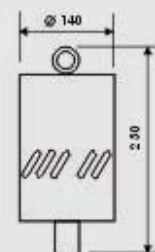

Material: Die Casting Aluminium
Lamp holder: E40
Max. MH 400W/HPS 400W
Protection standard: IP 44
Colour: black, silver, grey
Packing: 2 pcs/ctn (58.5x30x28 cm)
G.W: 24 KGS



XT51

Material: Die Casting Aluminium
Lamp holder: E40
Max. MH 400W/HPS 400W
Protection standard: IP 44
Colour: black, silver, grey
Packing: 6 pcs/ctn (69x26.5x50 cm)
G.W: 18 KGS



XT52

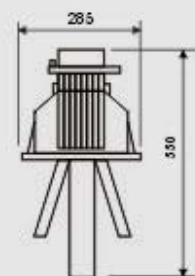

Material: Die Casting Aluminium
Lamp holder: E40
Max. MH 400W/HPS 400W
Protection standard: IP 44
Colour: black, silver, grey
Packing: 6 pcs/ctn (65x22.5x45 cm)
G.W: 11 KGS